



In Association with SVCH-Technologii, Moscow (Russia)

COMPANY PROFILE



KERONE



✓ **40 Years**
Manufacturing Excellence

✓ **Great Sale**
Support

About

KERONE

KERONE now renowned name in serving specialized need of customers with best quality and economical process Heating /cooling and drying products, manufactured in high quality environment by well trained and qualified workforce(special purpose machineries) .

KERONE is pioneer in application and implementation engineering with its vast experience and team of professionals. KERONE is devoted to serve the industry to optimize their operations both economically and environmentally with its specialized heating and drying solutions.

“ Enhance the value of customer operation through our customer need centric engineering solution. ”

Vision

- Turn into world leader in providing specialized, top-notch quality and ecological industrial heating, cooling and drying solution across the globe.
- To attain global recognition as best of quality and environment friendly engineering solution company.

Value

Proposition



Highly
Customized Product



Sound
Infrastructure



Adherence to
Standards



Timely
Delivery



Team of experts
Delivering Quality



Cost Effective
Solutions

Product Category

KERONE is a recognized leader in the field of Industrial Electrical heating equipments and control panels; Industrial Dryers, Coating Machine, Process Equipments, Industrial Ovens / PLC [TECO], Lab Equipments, Vacuum and Infrared Equipments , known for the quality and performance of its products and its services

Today we shall review some of these as listed below:-

<i>Industrial Dryers</i>	<i>Coating Machine</i>	<i>Mixing Kettle</i>	<i>Dehydrators</i>
<i>Industrial Ovens</i>	<i>Process Equipment's / Plants</i>	<i>Special Purpose Machine</i>	<i>IR Heating Systems</i>
<i>Microwave Heating Systems</i>	<i>RF Heating Systems</i>	<i>Industrial Heating Equipments</i>	<i>Industrial Heaters</i>

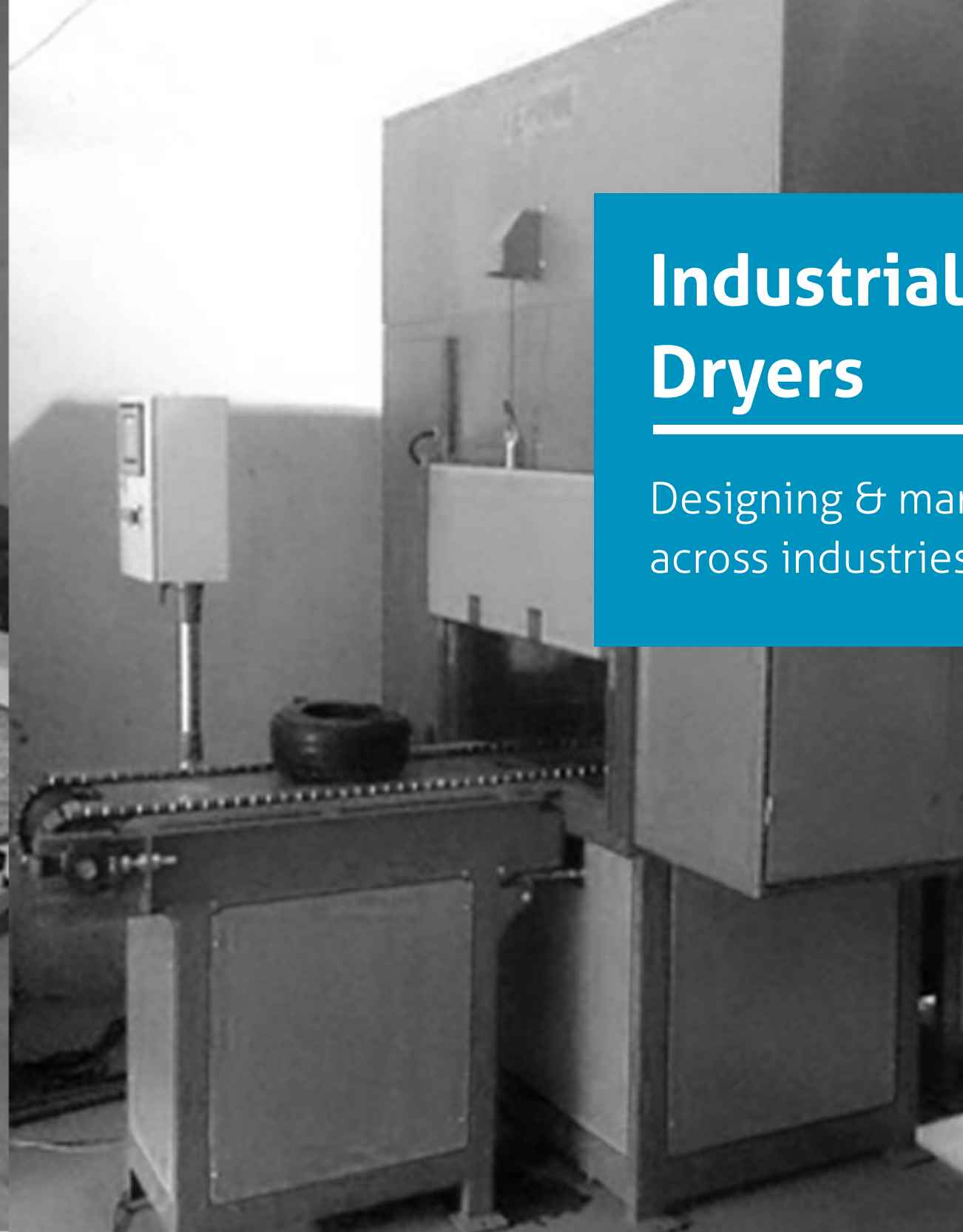

Industrial Dryers

Designing & manufacturing Industrial Dryers user across industries for various application :

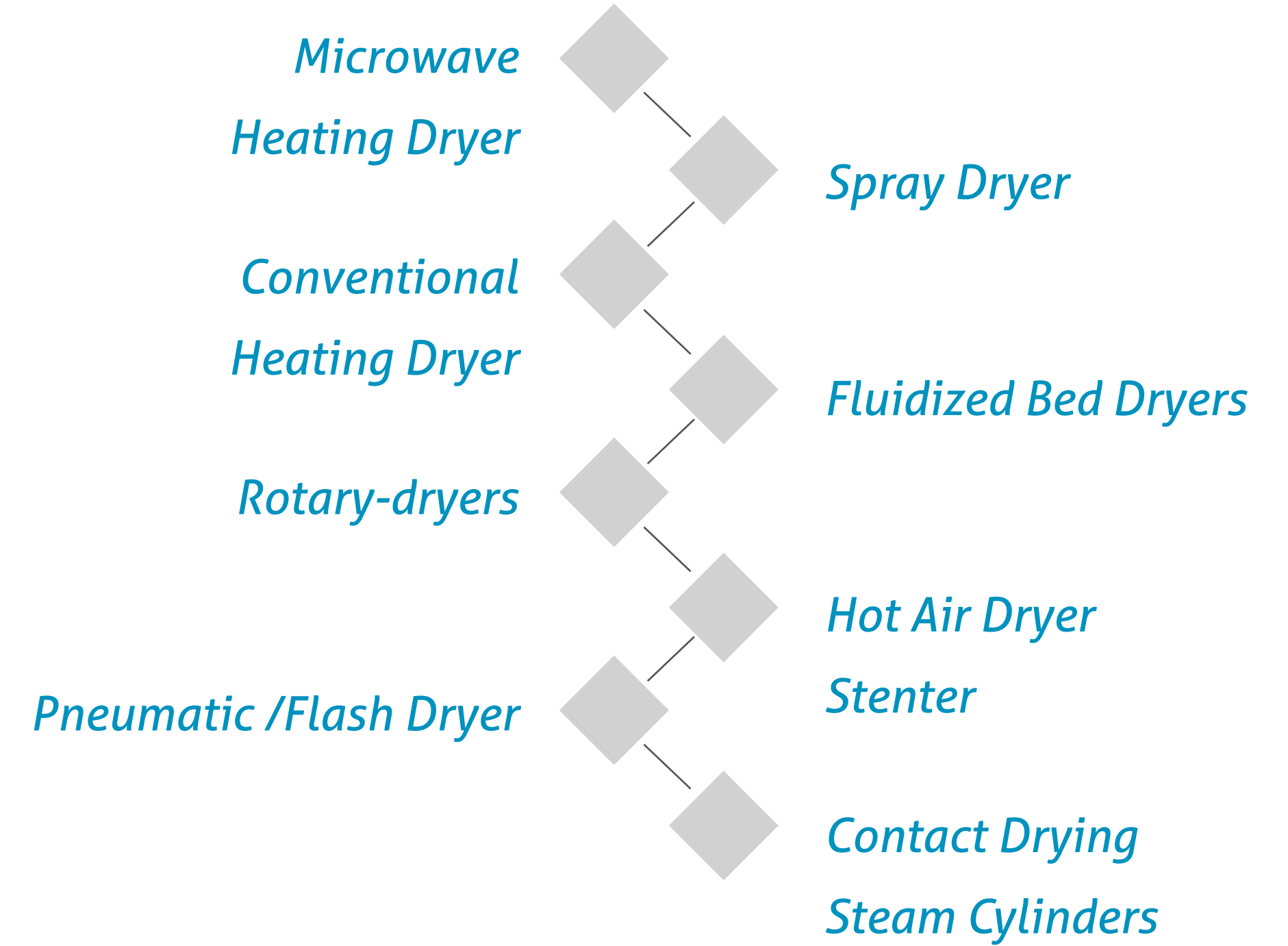

Coating Machine

Designing & Manufacturing Coating Machines across industries for various application :

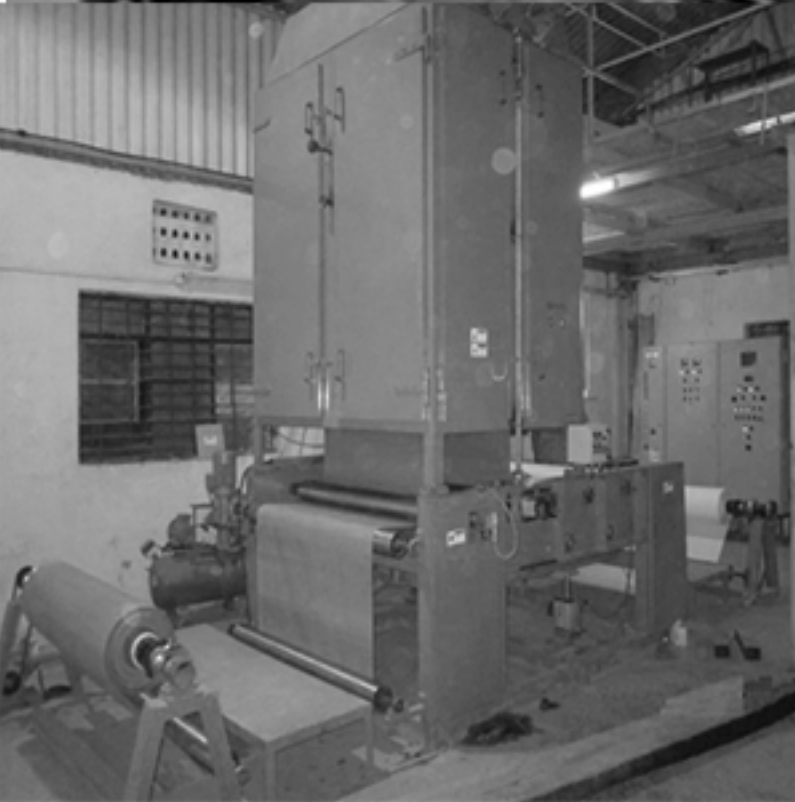
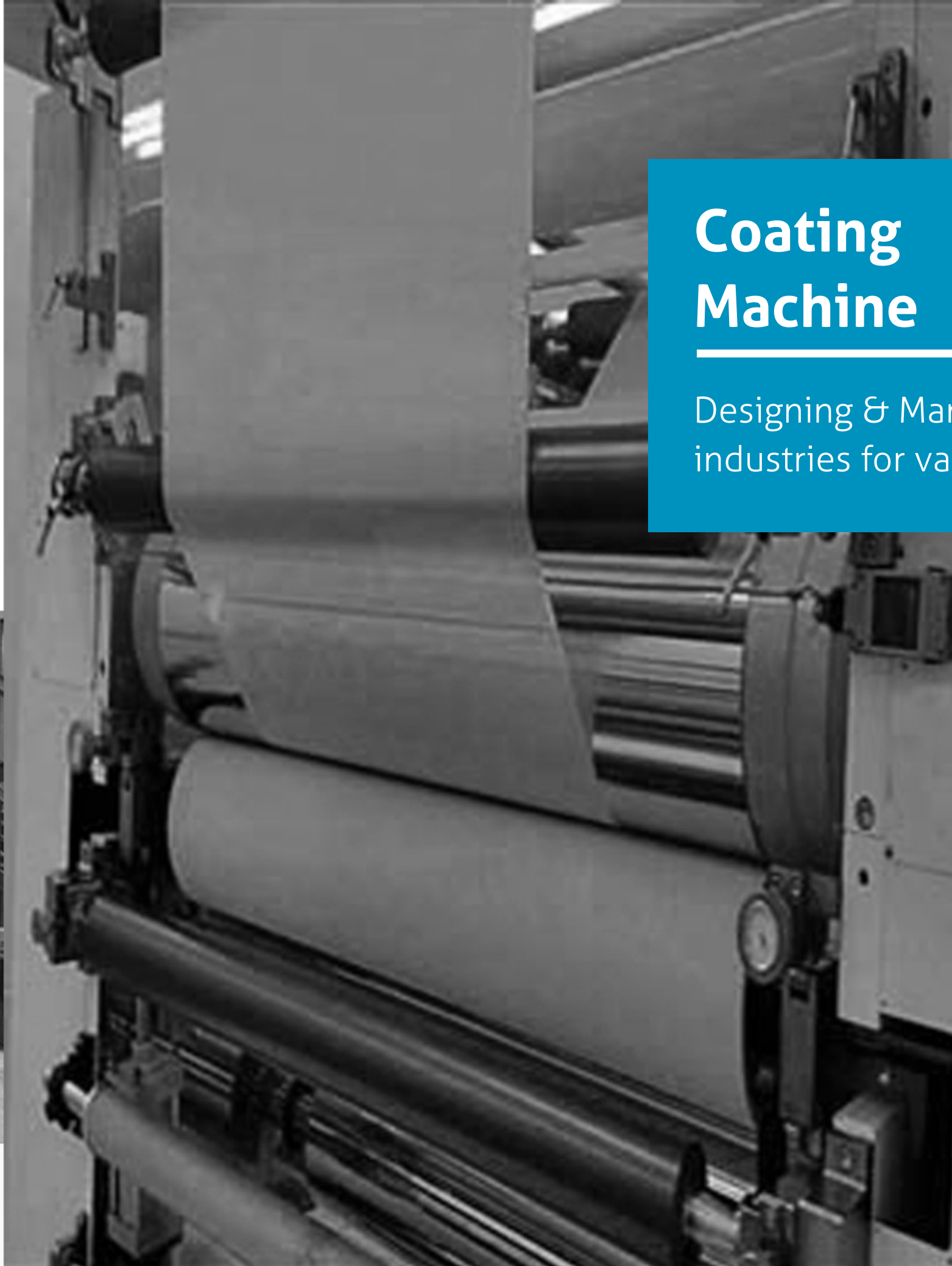

- Gravure Coating System
- Reverse Roll Coating Machine
- Knife Over Roll Coating Machine
- Air Knife Coating System
- Metering Rod Coating Machine
- Slot Die Coating System
- Curtain Coating Machine
- Immersion / Dip Coating Machine
- Hot Melt Coating Machine
- Pilot Coating Plant

Mixing Kettle

Our mixing kettles find application in various industrial processing such as :

Chemical Kettles

most widely find application in chemical plant , paint manufacturing, pharmaceutical industries and etc.

Across Industries

Mixing reactors are very commonly used for the solids dissolution, product mixing, chemical reactions, batch distillation, crystallization, liquid/liquid extraction and polymerization

Mixing Reactor with heating/cooling system

The heating/cooling systems embedded in the mixing reactors are such that it provides high level control and increase the overall system efficiency

Process Reactor

We manufacture process reactors of industrial scale, of various types such as batch type, continuous type, and semi-batch type

Dehydrators

We provide high end dehydrator that fits in requirement of our customers



Dehydration is preservation process helped the new age food industries, in the process of dehydration the water contains with the food is reduced to desirable level for application such as instant food, powder form of spices and fruits, noodles, soups, pastas and other food preparations.

In the process of dehydration the moisture within the food is removed from its micro-organism level, hence preventing it from degrading or spoiling over time.

The modern dehydrating techniques help to prevent the flavor, color, aroma and vitamin levels.

Application Areas

Digital Control Panel



Low Energy Loss

Robust In Design

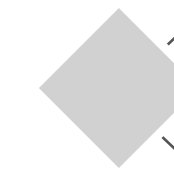

Controllable Moisture Level

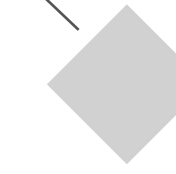

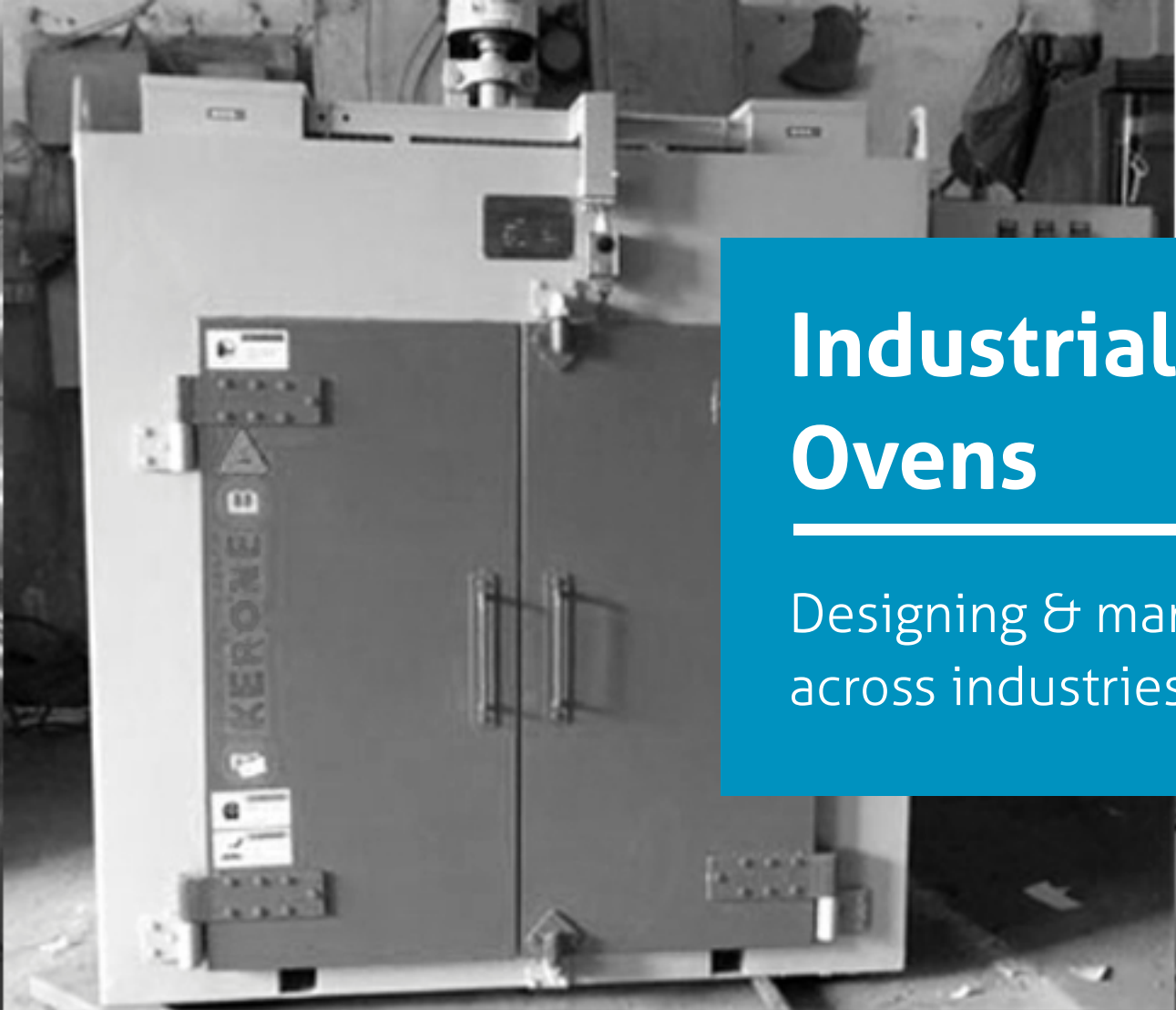

Industrial Ovens

Designing & manufacturing Industrial Ovens user across industries for various application :

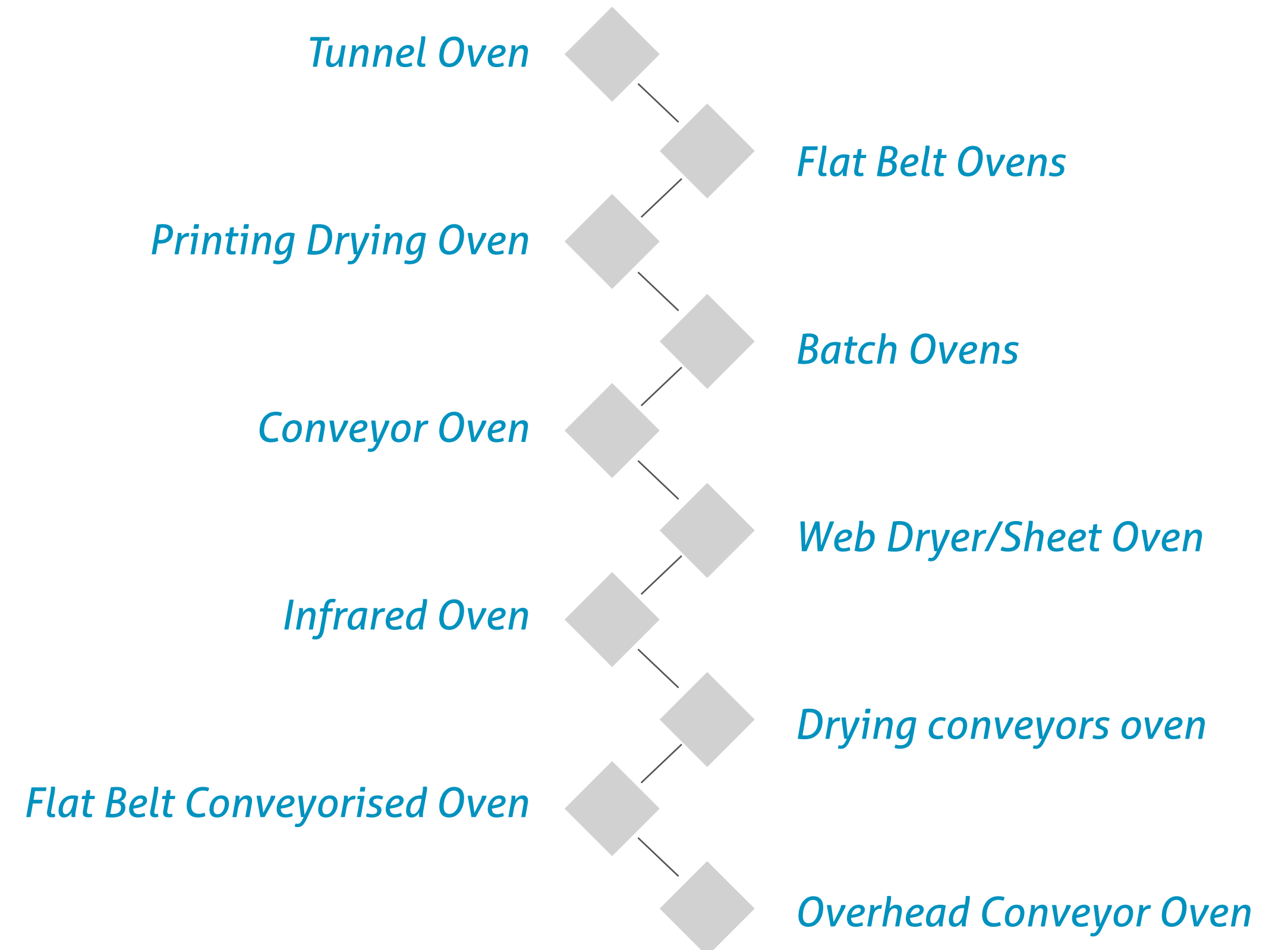



Process Equipments

The process equipments/plants are usually consisting of the following

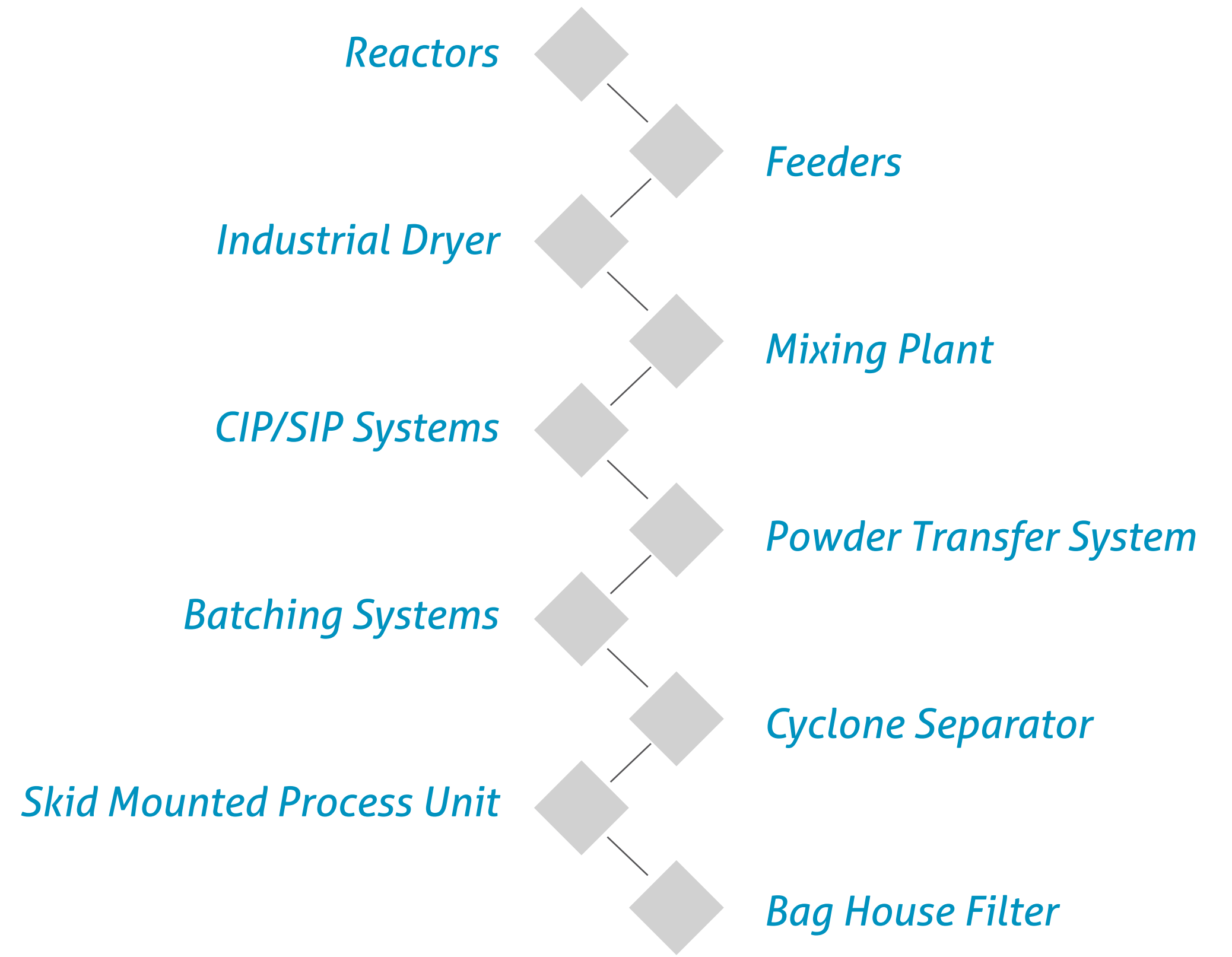

Special Purpose Machine

Designing & manufacturing Special Purpose Machines across industries for various application :

Design for Specialized Needs

Special purpose machines are those machines which are especially design and build to answer the specialized needs.

Across Industries

We provide design and build various heating systems for various special purpose applications across the industries.

Critical Project for KERONE

Every single special purpose machines are treated and handled as critical project for KERONE

IR Heating Systems

Designing & manufacturing Infrared heating system user across industries for various application :



Curing of Coatings

Plastic Shrinking

Plastic Annealing

Plastic Welding

Glass & Metal Heat Treating

Cooking

*Oven & Impregnation
Pants*

Chemical Industry

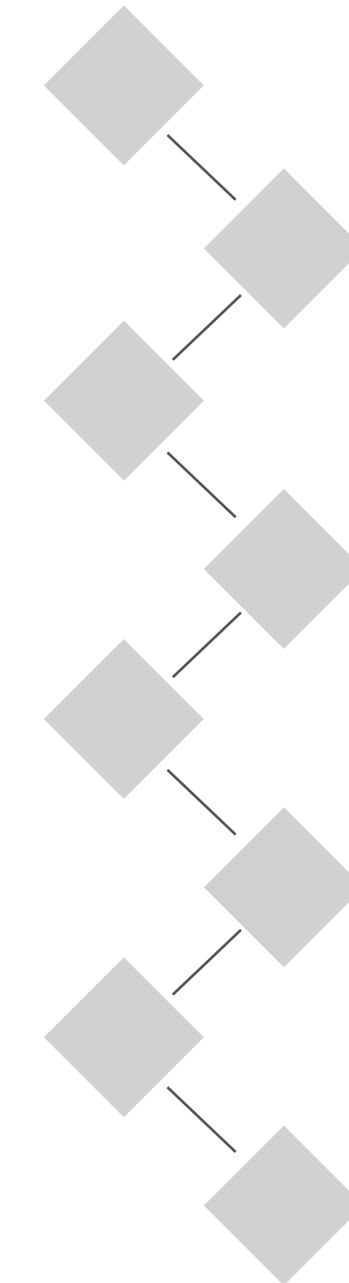

IR Heating Systems

Designing & manufacturing Infrared heating system user across industries for various application :



IR Flash Cure Dryer

IR Curing Unit

*Flat Belt
Conveyorised Oven*

IR Booster Ovens

Batch Ovens

IR Web Dryer

IR Tunnel Ovens

Tunnel / Clam Shell Ovens

Overhead Conveyor Ovens

IR Burner

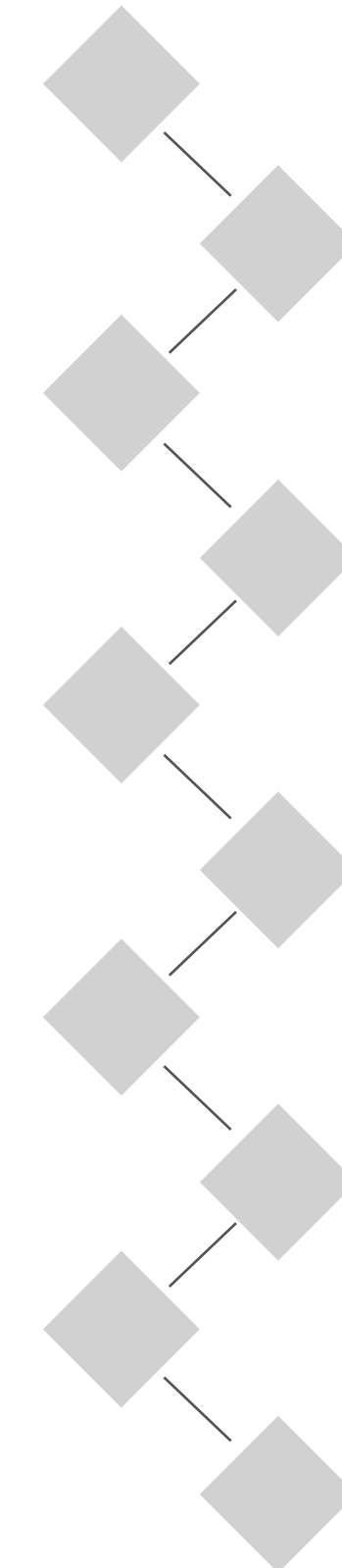

Microwave Heating Systems

Specialized in designing & manufacturing Microwave heating system that caters to specialized needs :

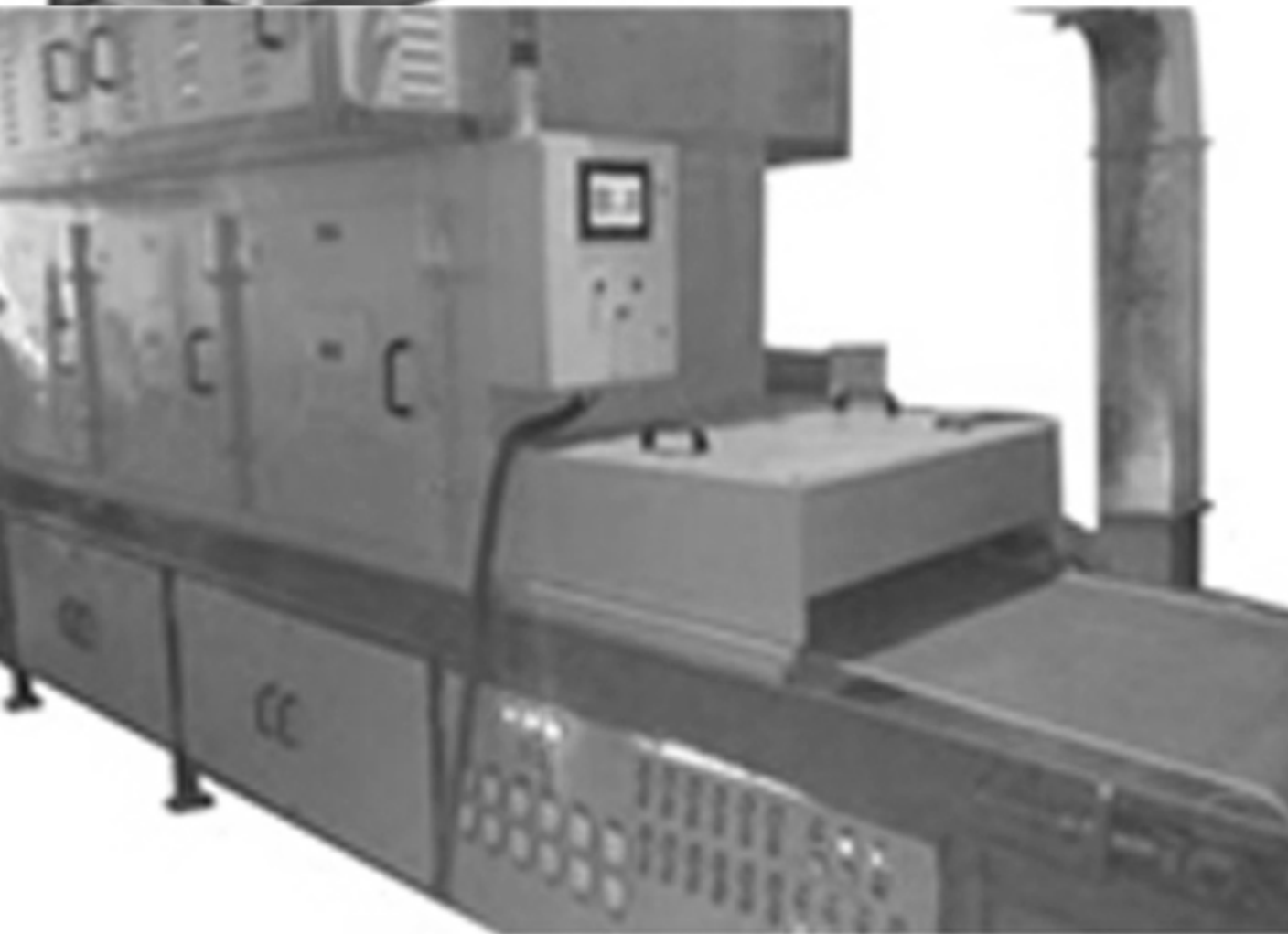

*Paper Coating
& Printing*

Food Processing

Plastics

Pharmaceutical

Textile Manufacturing

Wood Processing

Rubber Industry

Ceramic

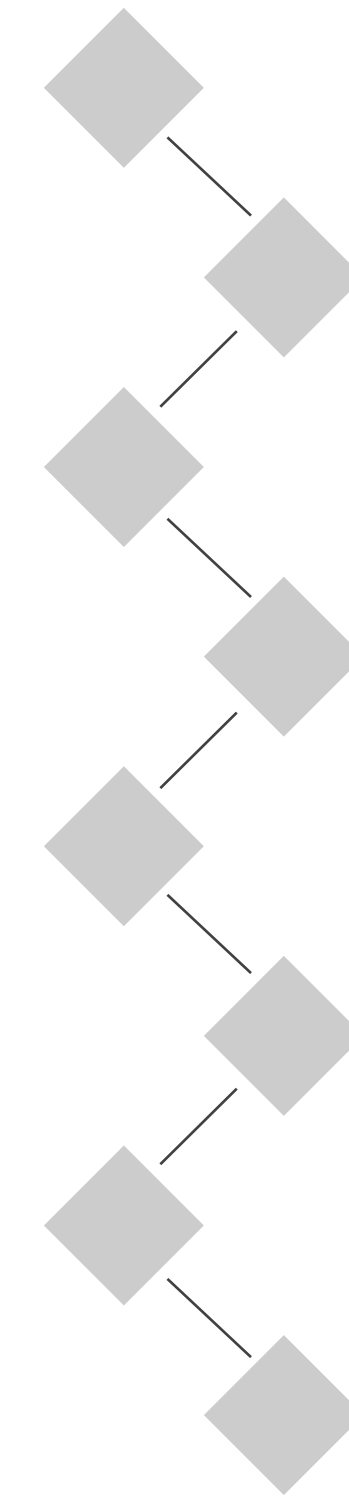



RF Heating Systems

Specialized in designing & manufacturing Radio Frequency (RF) heater & Dryer :

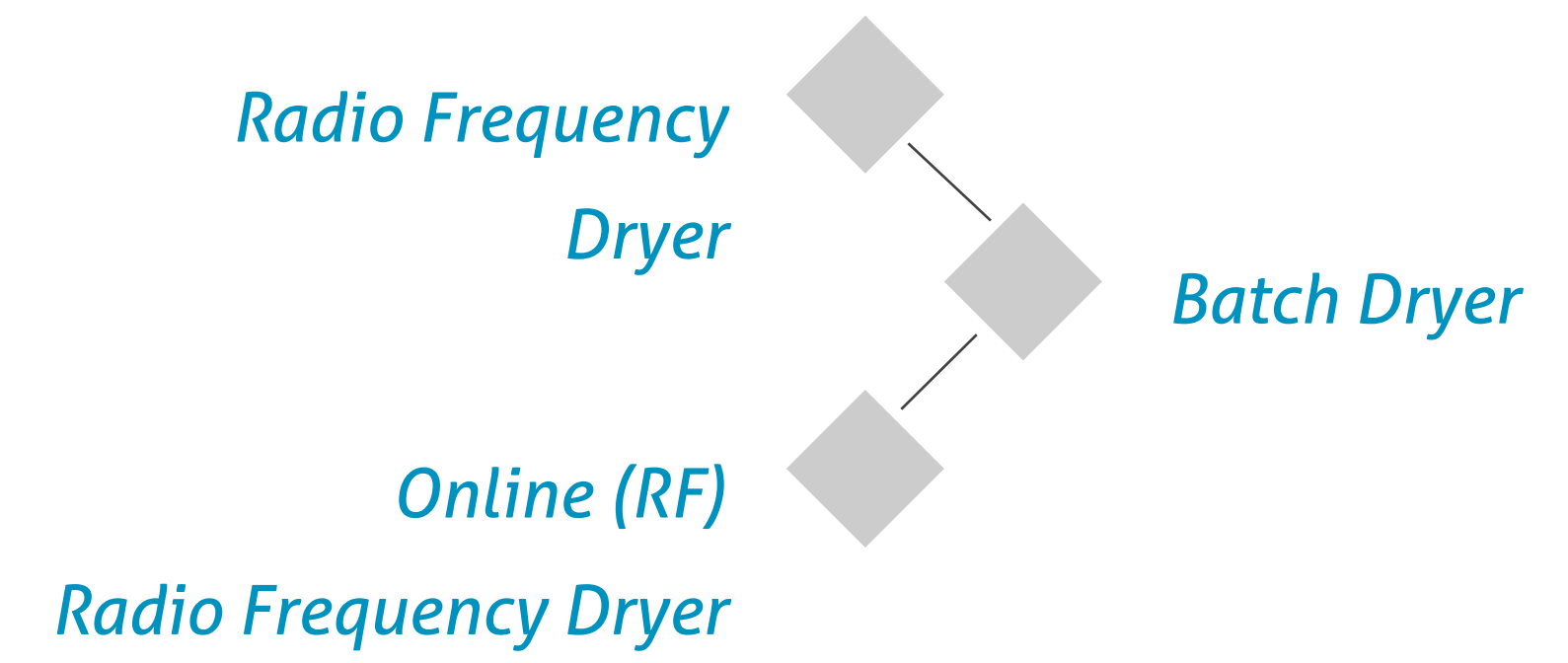
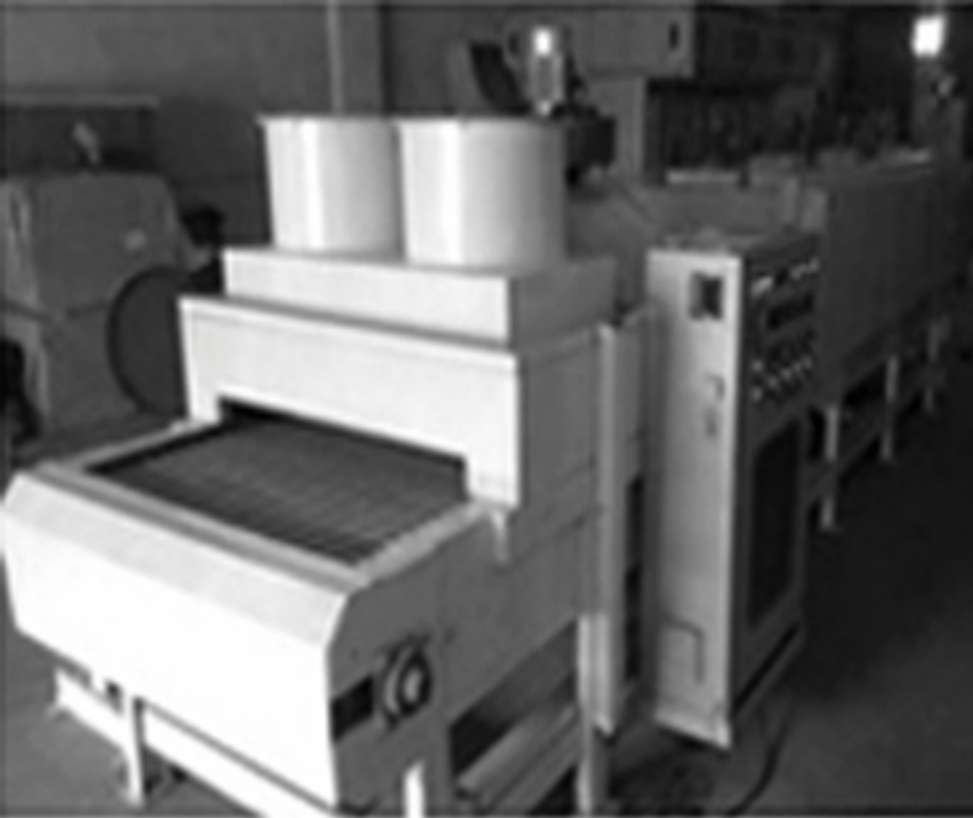

Industrial Heating Equipments

We provide high quality Industrial Heating Equipments :

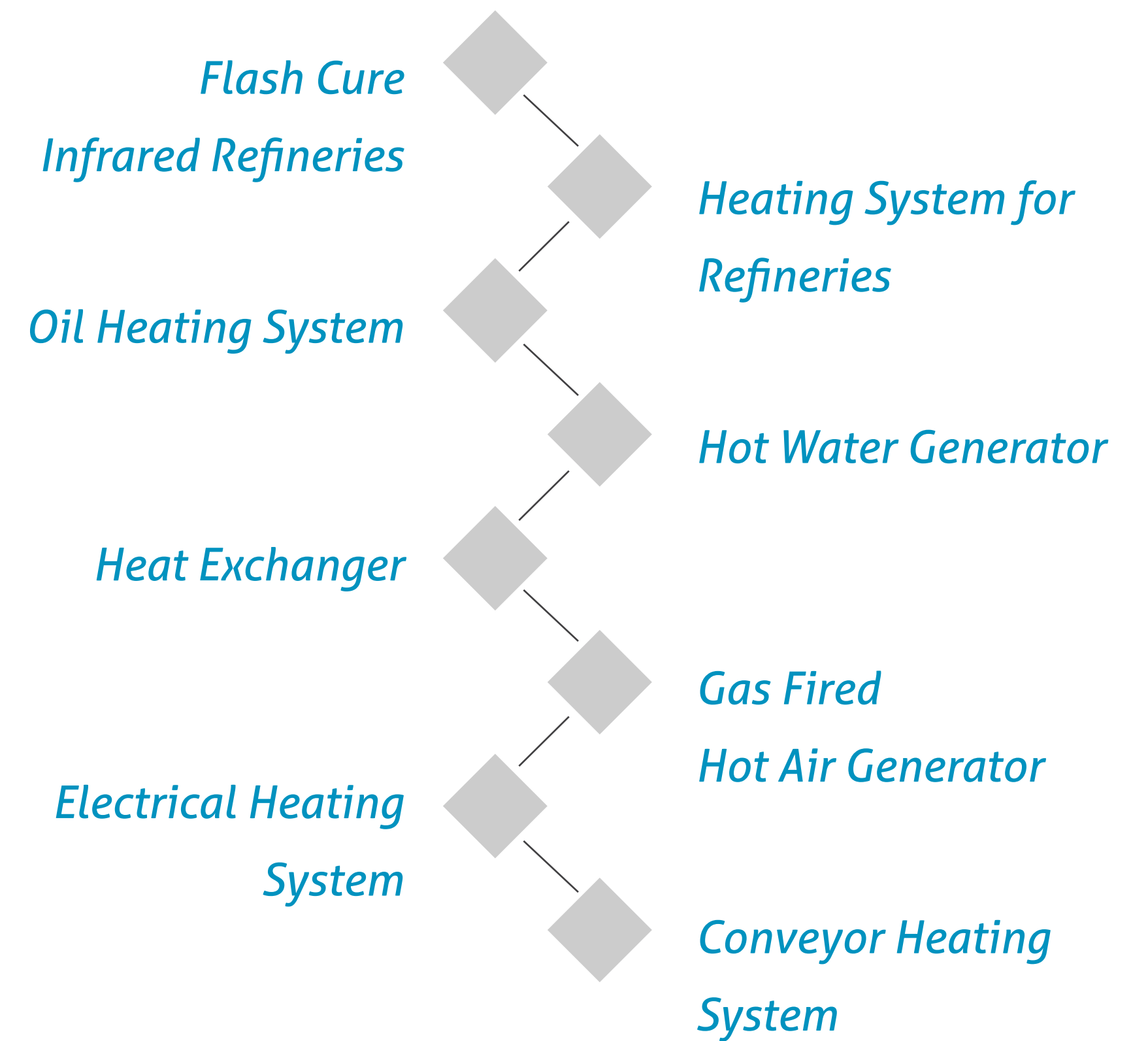
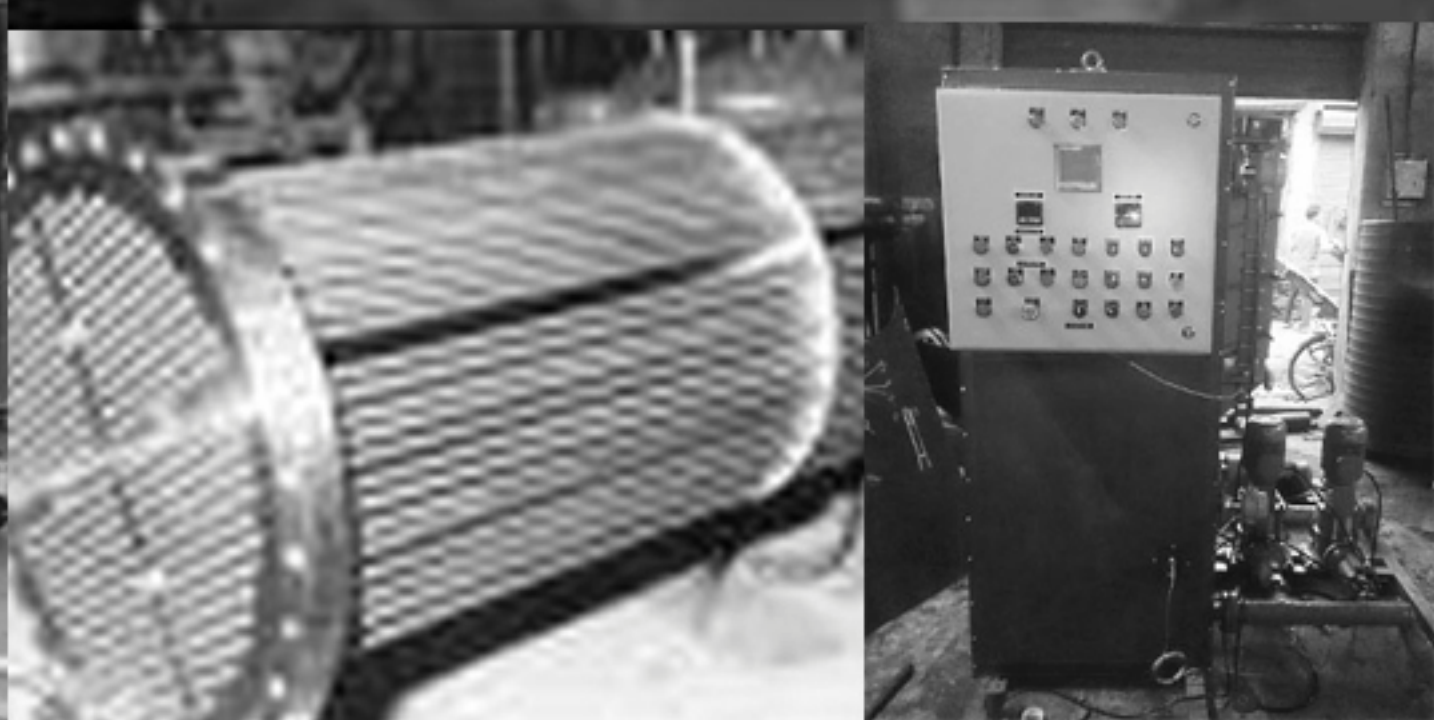

Industrial Heaters

We manufacture various types of Industrial Heater :

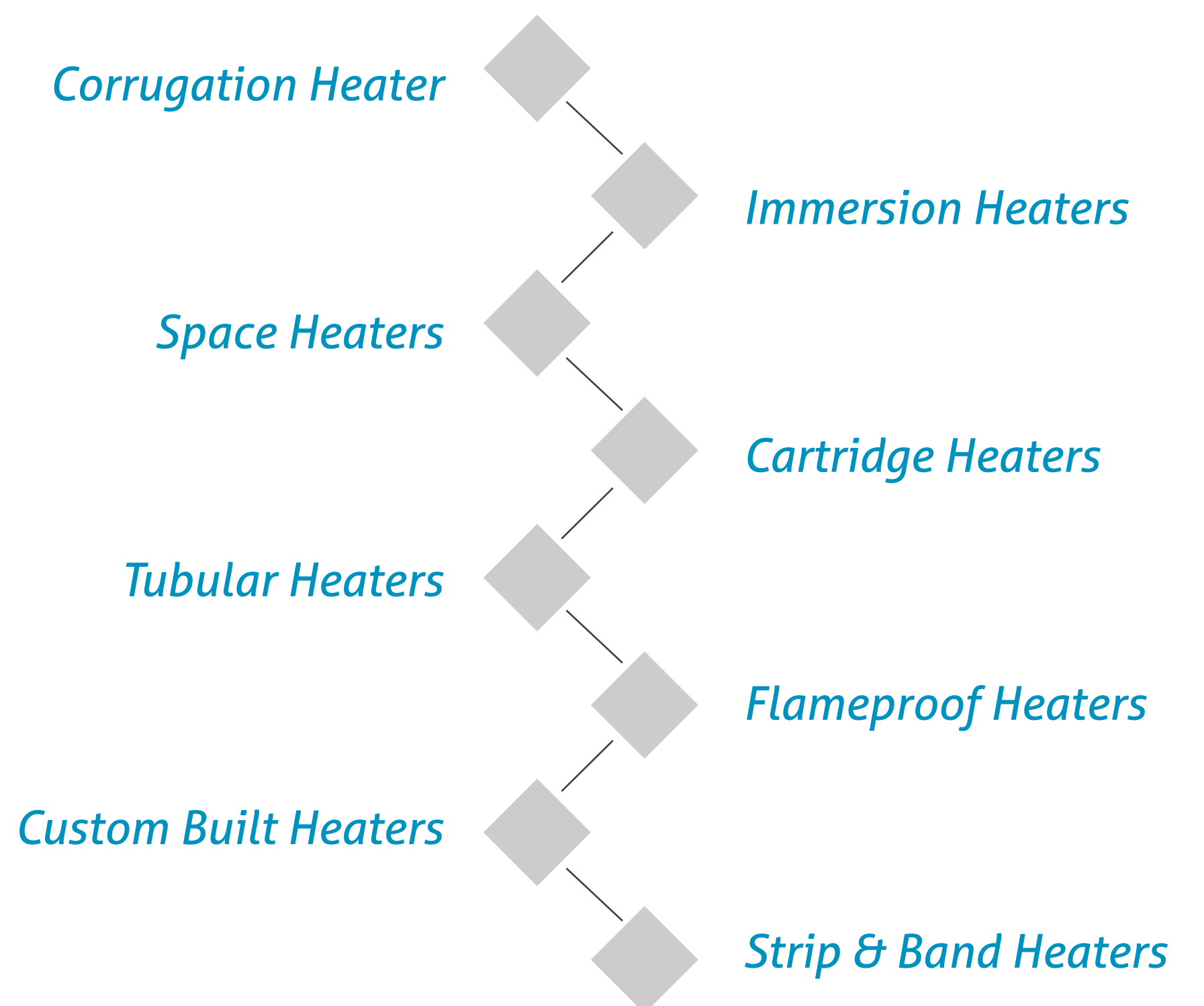
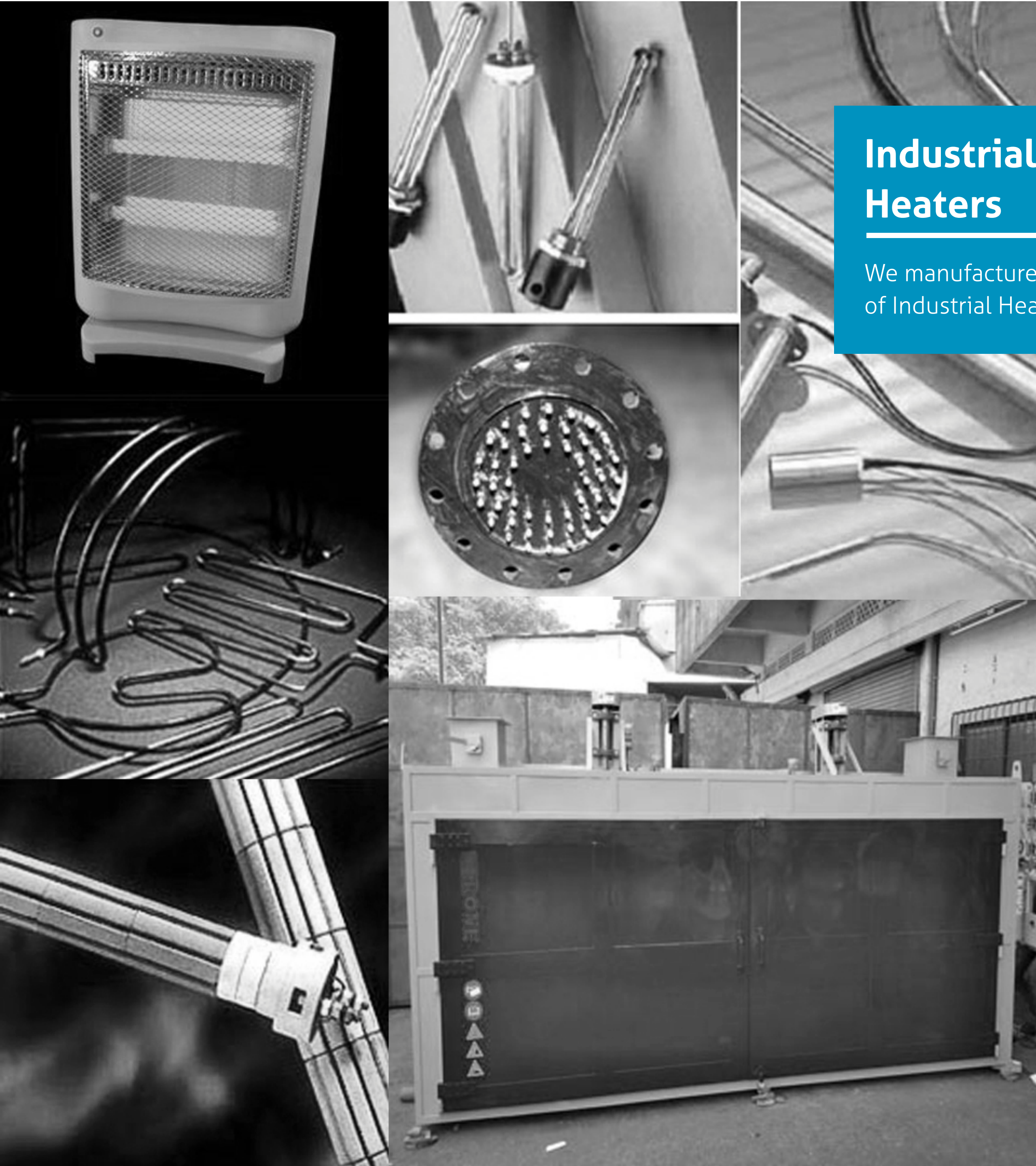

Trusted

Partners



Our
Clients

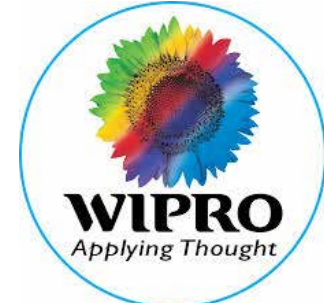



UNIT I

B/10, Marudhar Industrial Estate, Goddev Fatak
road, Bhayander(E), Mumbai-401105

Phone : +91-22-28150612/13/14

UNIT II

Plot No. B-47, Addl. MIDC Anandnagar,
Ambarnath (East), Dist. Thane- 421506

Phone : +91-251-2620542/43/44/45/46



EMAIL

info@kerone.com | sales@kerone.com | marketing@kerone.com

WEBSITE

www.kerone.com | www.kerone.net | www.keroneindia.com